



# INDEX

1.- GENERAL DESCRIPTION	4
2.- SHIPMENT	4
3.- TECHNICAL FEATURES	5
4.- OPERATION	6
5.- INSTALLATION	7
Generalities	7
Hydraulic connection	7
Electric conection	9
6.- START UP	10
DOSITEC - MP	11
DOSITEC - MD	12
DOSITEC - mA	13
DOSITEC - Q	16
DOSITEC - PRC	19
DOSITEC - MF	26
7.- MAINTENANCE	
List of parts	34
C.E. APPROVAL DECLARATION	39
WARRANTY	39



## SAFETY RULES

To avoid personal or environmental damages and to guarantee a proper operation of the equipment, the staff in charge of the installation, set up and maintenance of the equipment must follow the instructions of this manual, specially recommendations and warnings explicitly detailed. In addition, specific instructions for the chemical products to be dosed should be followed.



## 1.- GENERAL DESCRIPTION

The dosing pumps DOSITEC are heavy duty, high precision, electric diaphragm pumps for dosing liquid products.

DOSITEC dosing pumps are manufactured with materials that can resist most chemicals products, even acids. They are designed for all sorts of processes where it is necessary to dose a product into a hydraulic network, such as: food, textile, chemical industry, water treatments, etc. (See materials in Technical Features). In case there is any doubt about compatibility of materials with the products to be used please contact ITC S.L. Technical Service.

The metering pump has been designed to feed liquids with capacities from 0 to 15 l/h and pressures from 0 to 10 bar. They also include a connexion for a level switch..

DOSITEC models:

DOSITEC -MP: Manual Regulation from 0 to100% by potentiometer

DOSITEC -MD: Manual Regulation from 0 to100% by keyboard

DOSITEC - Q: Proportional regulation

DOSITEC - mA: Analogic regulation by a current signal

DOSITEC - PRC: Control PH or ORP(Redox)

DOSITEC - MF: Multifuntion (Manual flow regulation / proportinonal / Analogical 4-20mA / with timer)

## 2.- SHIPMENT

The original packaging is prepared to transport and storage the goods, if it is done in dry, aired spaces and far from sources of heat, always keeping the pump in vertical position.

Inside the pack it is included:

Dosing pump.

Semirigid PE hose, white, lenght 2m.

Flexible PVC hose transparent crystal type, lenght 2m.

Injection valve 3/8" BSP-M

Filter

Manual of instructions



### 3.- TECHNICAL FEATURES

Flow l/h	Pressure Bar	C/min	Volum ml/cycle	Stroke length mm	Power supply Volts	Power Watts	Weight Kg
2.5	10	120	0.35	0.8	230V AC	37 (0.16A)	3
2	20	120	0.28	1.0	230V AC	58 (0.30A)	3.8
6	7	120	0.83	1.0	230V AC	37 (0.16A)	3
9	10	120	1.25	1.4	230V AC	58 (0.30A)	3.8
2.5	10	120	0.35	0.8	12V DC	24 (2 A)	3
6	7	120	0.83	1.0	12V DC	24 (2 A)	3



Maximum suction high: 2 m  
Minimum injection pressure: 0,5 Bar

- IP 65 protection.
- Ambient temperature temperature: 5-40 °C
- Liquid temperature temperature: 5-40 °C
- Standard power supply: 230 V (+/-10%) a.c.50 / 60 Hz single phase.
- Optional power supply: 120 V a.c. 50 / 60 Hz single phase. / 12V d.c.

#### FLOW - PRESSURE

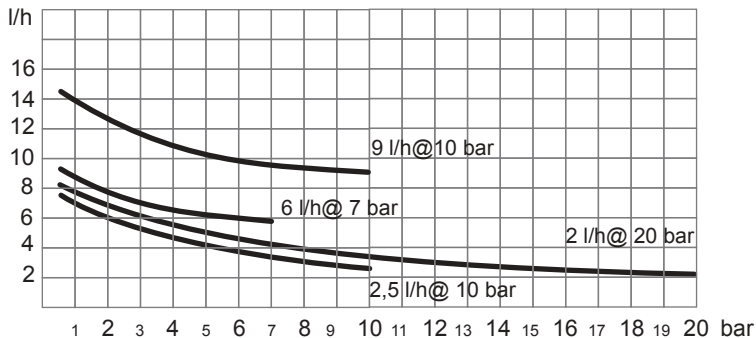

#### LIQUID ENDS MATERIALS:

DIAPHRAGM:	PTFE.
PUMP HEAD:	PVDF
NIPPLES:	PVDF.
VÁLVES BODY:	PVDF
VÁLVES BALL:	Ceramic
O-RINGS:	FPM ( available in EPDM)
SUCTION HOSE:	PVC flexible.
DISCHARGE HOSE :	Polyethylene.
FILTER:	Polypropylene



## DIMENSIONS

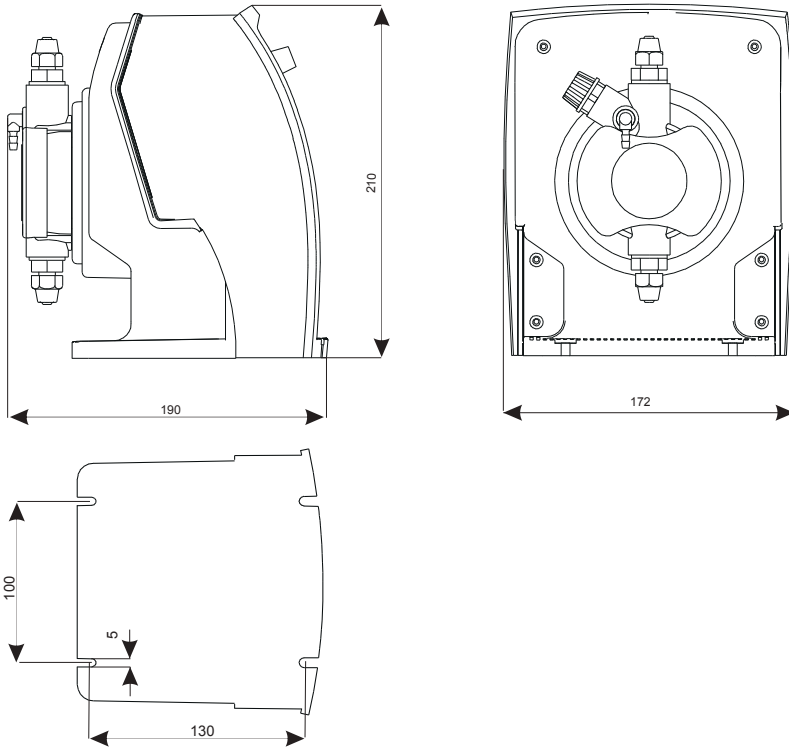

## 4.- OPERATION

The metering pump is activated by a PTFE diaphragm mounted on a piston of an electromagnet.

When the piston of the electromagnet is attracted, a pressure is produced in the pump body with an expulsion of liquid from the discharge valve. Once the electric impulse is finished a spring brings the piston back to the initial position, with a recall of liquid through the suction valve.

As the operation is simple the pump does not need lubrication, therefore maintenance is reduced almost to zero.

The materials used for the construction of the pump make it particularly suitable for aggressive products.



## 5.- INSTALLATION

### GENERAL

Install the pump in a dry place and well away from sources of heat and, in any case, at environmental temperatures not exceeding 40°C. The minimum operating temperature depends on the liquid to be pumped, bearing in mind that it must always remain in a liquid state.

Place the pump vertically over a rigid surface totally horizontal.

### HYDRAULIC CONNECTION

Properly design either in the suction and injection pipe is required, avoiding long length and bending pipes as much as possible.

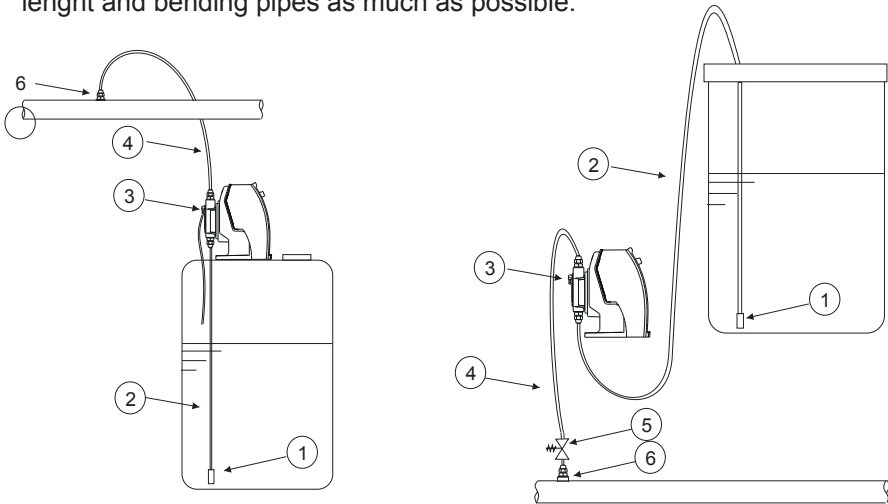

- ① SUCTION FILTER
- ② SUCTION PIPE
- ③ PRIMING VALVE

- ④ INJECTION PIPE
- ⑤ COUNTER-PRESSURE VALVE
- ⑥ INJECTION VALVE

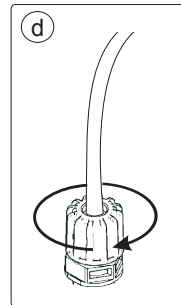
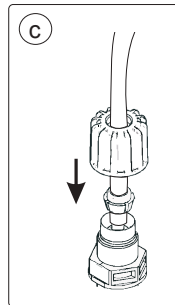
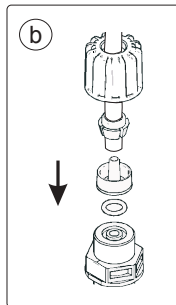
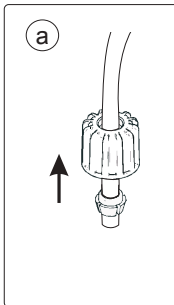



To prime the pump, first connect the priming hose to the priming valve and drive the other side of the hose to a safety place to pour the air mixed with product.

Open the priming valve and start the pump at maximum flow until having only liquid in the priming outlet.

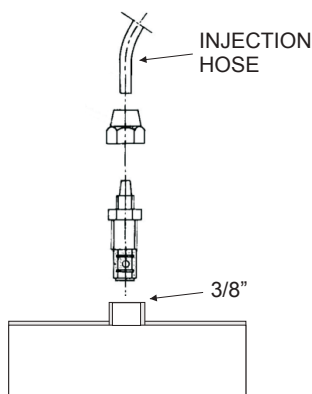
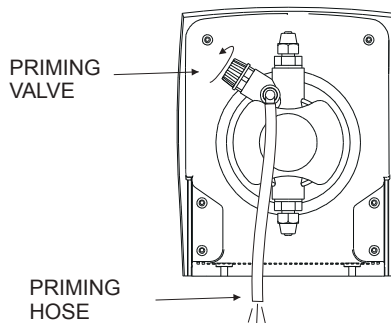

Select the most appropriate injection point in the pipe to inject the product, and place there a 3/8" part to connect the Injection valve.



Install a safety valve in a derivation as near as possible from the pump, in order to protect it and the whole installation from possible over-pressures. This derivation Must derive the liquid to a safe place.

## ELECTRIC CONNECTION



The electric protection of the motor must be installed and adjusted following its nominal intensity (overloaded switch disjuntor).

A disconnection dispositive must be installed in case of emergency.

The equipment must be protected to avoid untimely sudden starts.



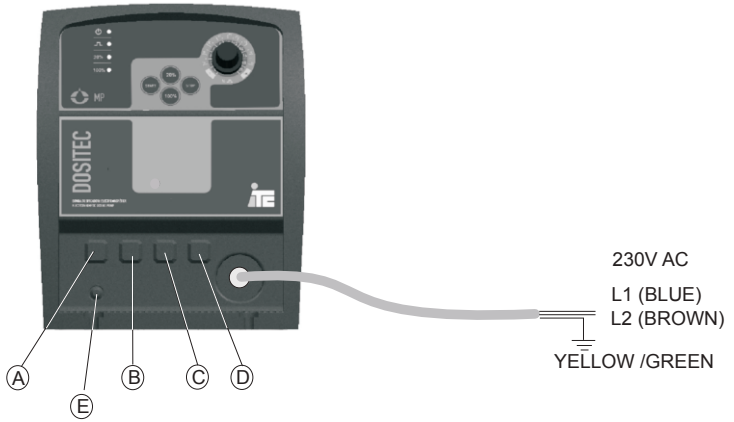

	MD	Q	mA	PRC	MF
A					1- 2- 3- Ground 4- Reset
B		1- 2- 3- Pulse input (+) 4- Pulse input (-)	1- 2- 3- Signal mA (+) 4- Signal mA (-)		1- Signal input mA (+) 2- Signal input mA (-) 3- Pulse input (+) 4- Pulse input (-)
C		1- 2- 3- Level switch 4- Level switch	1- 2- 3- Level switch 4- Level switch	1- Output mA (+) 2- Output mA (-) 3- Level switch 4- Level switch	1- Flow sensor. 2- Flow sensor. 3- Level switch 4- Level switch
D		1-Output relay.AL3.NO 2- 3-Output relay (Com) 4-		1- Alarm relay (NO) 2- Alarm relay (NC) 3- Alarm relay (Com) 4-	1- Alarm relay (NO) 2- Alarm relay (NC) 3- Alarm relay (Com) 4-
E				Connector BNC pH sensor ORP (redox) sensor	

### Electrical connection of the dosing pump with electric loads (motors, pumps, electrovalves...)

To avoid damaging the dosing pump (DP) at the disconnection of other pumps or electric motors (M), the following diagrams must be used:

Option 1

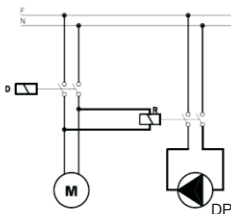

Option 2

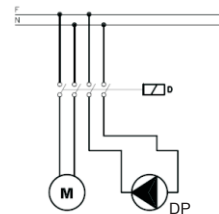



## 6.- START UP AND REGULATION



**BASE:** Check that the pump is properly secured to the base.



**CHECKING THE HYDRAULIC CIRCUIT:** Check that all valves are open and the liquid from priming valves are derived correctly



**CHECKING OF PUMP** Tighten the four cylinder bolts to 2,5Nm



**CHECKING OF PUMP:** Visually/hearing check the proper operation of the pump.



**OVER-PRESSURE PROTECTION:** Adjust the safety valve to the correct pressure to protect the installation without exceeding the pump nominal pressure.



**ELECTRIC PROTECTION:** Adjust the electric protection to the pump nominal current.



### **SULPHURIC ACID DOSIFICATION**

Replace crystal suction hose with a polyethylene discharge hose. Use PTFE hose for the suction and discharge.

Previously, take away from inside the pump all water present (if water is mixed with sulphuric acid, an overtemperature is caused, damaging the pump).



## DOSITEC MP

### MANUAL REGULATION DOSING PUMP

Flow regulated with a potentiometer, it control the impulsion frequency. Adjust of the frequency from 0 to 100%. Special flow regulation at 0-20% frequencies.

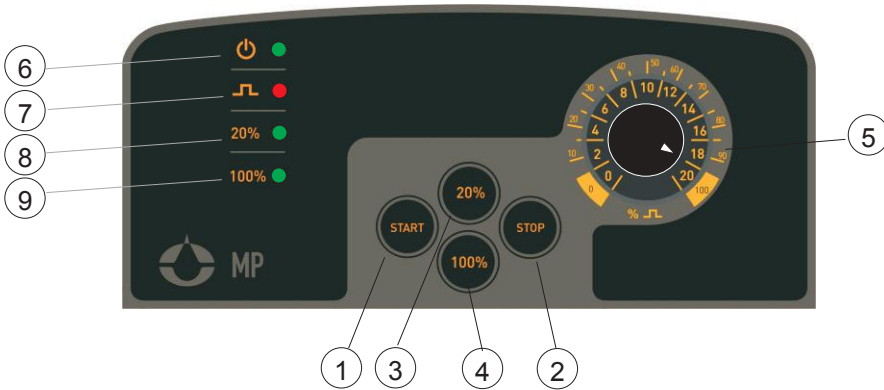

- 1 START
- 2 STOP
- 3 Regulation at 20% maximum
- 4 Regulation at 100% maximum
- 5 Adjust of the potentiometer in percentage (0-100%)
- 6 Power LED
- 7 Injection LED
- 8 20% regulation LED
- 9 100% regulation LED

### ACCESSORIES

- 1 flexible transparent PVC suction hose 2m
- 1 semirigid white PE injection hose 2m
- 1 injection valve 3/8"
- 1 filter
- 1 user manual
- 1 flexible transparent PVC priming hose.



## DOSITEC MD

### DIGITAL DOSING PUMP WITH MANUAL REGULATION

Flow set with keyboard, from 0 - 100%.

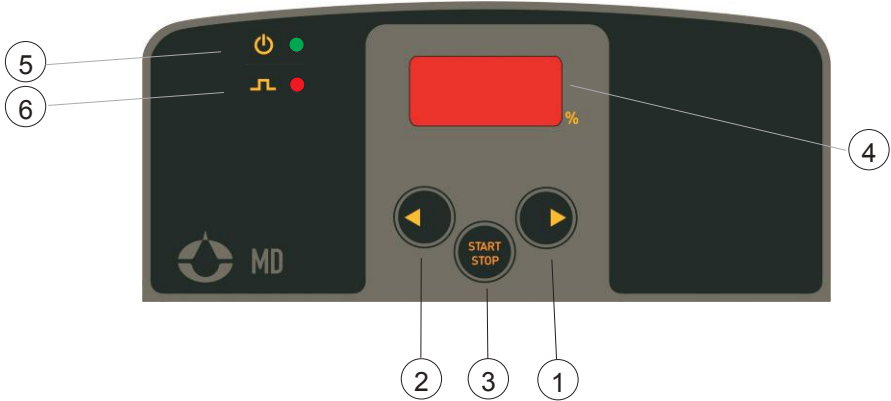

- 1 Increase value
- 2 Decrease value
- 3 START /STOP
- 4 Display
- 5 Power LED
- 6 Injection LED

### ACCESSORIES

- 1 flexible transparent PVC suction hose 2m
- 1 semirigid white PE injection hose 2m
- 1 injection valve 3/8"
- 1 filter
- 1 user manual
- 1 flexible transparent PVC priming hose.

### LEVEL ALARM

Pump stops, red LED is on when detects no product for 5 seconds. Level sensor is required.



## DOSITEC mA

### ANALOGIC 4-20mA DOSING PUMP

Dosing pump, flow regulated through a 4-20mA external signal.

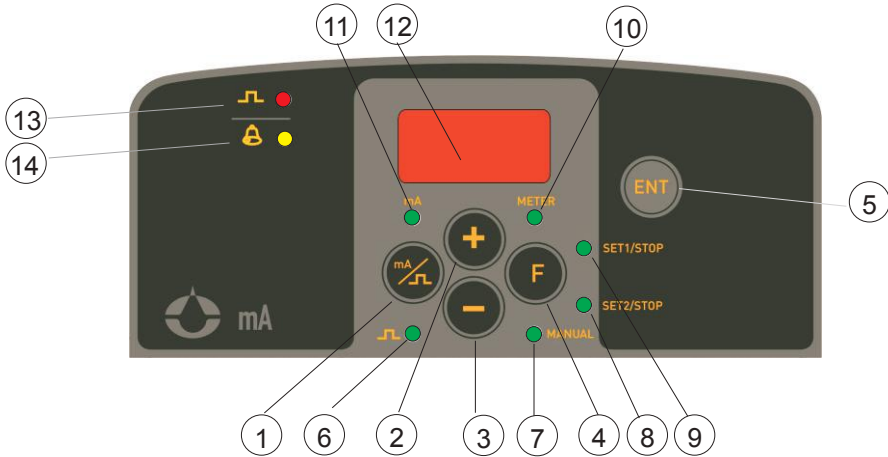

- 1 Displays mA or pulse
- 2 Increase value
- 3 Decrease value
- 4 Select function
- 5 Enter
- 6 Pulse LED display.
- 7 Manual selection LED
- 8 SET POINT 2 / STOP LED
- 9 SET POINT 1 / STOP LED
- 10 Meter LED
- 11 mA LED display
- 12 Display
- 13 Injection LED signal
- 14 Level alarm LED

### ACCESSORIES

- 1 flexible transparent PVC suction hose 2m
- 1 semirigid white PE injection hose 2m
- 1 injection valve 3/8"
- 1 filter
- 1 user manual
- 1 flexible transparent PVC priming hose.



## **LEVEL ALARM (FAO)**

Pump stops, displays FAO, and the alarm LED is on when detecting no product for five seconds. A level sensor is required.

## **POWER ON THE PUMP**

The pump starts with METER, pulse per minute is displayed.

Use mA / pulse, to display input signal / injections per minute.

## **PRIMING**

Select MANUAL function and select the frequency to prime the pump.

F to select MANUAL

+/- to change the injection/min ( a 75% of the maximum frequency is recommended)

## **PROGRAMMING**

### **SET POINT 1**

Sets the input signal value for the minimum flow, and the frequency of the injections.

F to select SET1/STOP, show the frequency of the injections set.

+/- to change the frequency of the injections (puls/min), for minimum flow (000 for stop)

mA/pulse to select mA.

+/- to change the value of the input signal (mA) for the minimum flow.

Confirm with ENT.

F to select SET POINT 2.



## SET POINT 2

Sets the value of the input signal for the maximum flow, and the frequency of the injections.

F to select SET2/STOP, shows the frequency of the injections.

+/- to change the frequency of the injections (pulse/min), for maximum flow.

mA/pulse to select mA.

+/- to change the value of the input signal (mA) for the maximum flow.

Confirm with ENT.

### Direct mode

The pump works with an input signal of a higher value than the minimum frequency (SET1), increasing the frequency of the injections (flow), proportionally to the increase of the signal, to the maximum frequency of the injections (SET2).

### Reverse mode

Increasing the value of the input signal means a reduction of the flow. Maximum value of the input signal in mA at SET1, and the minimum value in SET2.

**NOTE:** A higher frequency at SET1 than at SET2 is not allowed, so the reverse mode can only be set setting a higher value of the signal (mA) at SET1.

#### Example 1:

**Dositac mA, Flow 10 l/h, Pressure 5 Bar, Signal 4-20 mA**

4 mA = 0 l/h = 0%  
12 mA = 5 l/h = 50%  
20 mA = 10 l/h = 100%

#### Example 2:

**Dositac mA, Flow 10 l/h, Pressure 5 Bar, Signal 4-20mA programmed in Reverse mode.**

4 mA = 10 l/h = 100%  
12 mA = 5 l/h = 50%  
20 mA = 0 l/h = 0%



## DOSITEC Q

### PROPORTIONAL DOSING PUMP

Dosing pump with a water counter input. Sets a proportion between the pulses from the water counter and the injections of the dosing pump.

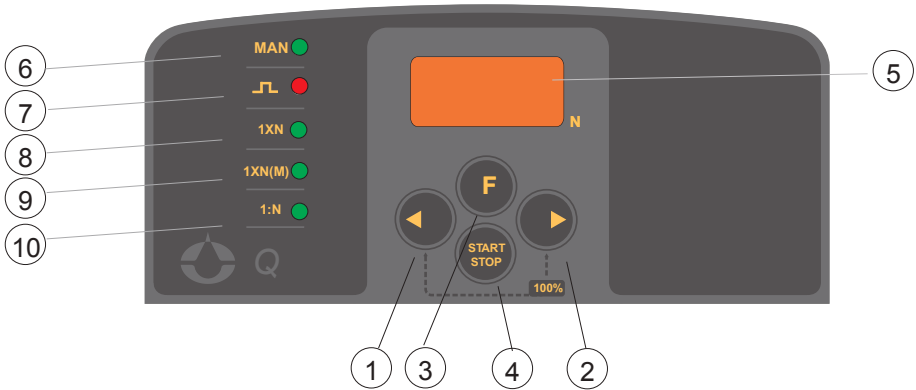

- 1 Decrease value
- 2 Increase value
- 3 Select function
- 4 START / STOP
- 5 Display
- 6 Manual LED
- 7 Injection LED
- 8 1xN LED 192.168.240.201:5
- 9 1xN(M) LED
- 10 1:N LED

### ACCESSORIES

- 1 flexible transparent PVC suction hose 2m
- 1 semirigid white PE injection hose 2m
- 1 injection valve 3/8"
- 1 filter
- 1 user manual
- 1 flexible transparent PVC priming hose.





## LEVEL ALARM (AL1)

Pump stops, displays AL1 and the alarm LED is on when detecting no product for five seconds. A level sensor is required.

## PROGRAMMING

### MANUAL MODE

F to select function.



- 1) Select injection frequency with ◀ ▶ .
- 2) Confirm with START/STOP.
- 3) START/STOP to start.

## PROPORTIONAL MODE

F to select function.

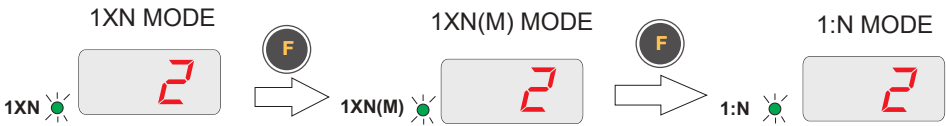

- 1) Set proportion value with .
- 2) Confirm with START/STOP.
- 3) START/STOP to start

Note: N max. = 999.

### 1XN MODE

For each pulse received by the water counter, injects N times. Frequency of the injections is set in manual mode.

Example:

- Pump in **1XN** mode.
- Value **N=20**



Water counter gives a pulse to the pump. The pump dosifies 20 injection strokes, while the pump is dosing pulses from water counter are ignored. Once the pump has finished 20 strokes, it waits for another pulse of the water counter to start again.

## **1xN (M) MODE**

The same as 1xN mode, but injection frequency is adapted to the time between each pulse received. If the pump receives pulses while it is dosing, injection frequency is increased if possible.

Example:

Pump receives a pulse and injects "N" times at the maximum frequency (120pulse/min).

When it receives a second pulse, time between both pulses is used to calculate the injection frequency so injection strokes are spaced in time, the limit is the maximum frequency.

## **Overpulse Alarm (AL3)**

When the pending injection cycles are higher than 4, AL3 is displayed, pump continues dosifying, but the pending cycles are missed.

## **1:N MODE**

The pump needs to receive N pulses to inject once. N is set for the user.

Example:

- Pump set mode **1:N**
- Value: **N=20**

After receiving 20 pulses of the watermeter, the pump injects once.

NOTE: 70 pulses/second is the maximum frequency accepted from the watercounter.

## **PRIMING**

Pump fast priming, press at the same time ◀ ▶ .



# DOSITEC PRC

## PH, ORP (REDOX) DOSING PUMP

Microcontrolled dosing pump for PH or ORP (redox) control.



- 1 Decrease value
- 2 Increase value
- 3 ESCAPE
- 4 On/Off
- 5 ENTER
- 6 Display
- 7 Power LED
- 8 Injection LED
- 9 Alarm LED

## ACCESSORIES

- 1 flexible transparent PVC suction hose 2m
- 1 semirigid white PE injection hose 2m
- 1 injection valve 3/8"
- 1 filter
- 1 user manual
- 1 flexible transparent PVC priming hose.



## DEFAULT PARAMETERS

Measure selection	pH
Setpoint	7.2
Hysteresis	0.1
Control	ácido
ON/OFF - Proporcional control	ON/OFF
Proportional control start value	Set point+1pH
First point calibration procedure	---
Second point calibration procedure	---
Lowest Alarm value	0.00
Highest Alarm value	14.00
Over-dosing alarm value	99:59 (h:m)
Menu: BASE / FULL	BASE
Password	Disabled
Delay powering on	00:03 (m:s)
Delay exit calibration menu	05:00 (m:s)
Calibration 4 mA output	4 mA
Calibration 20 mA output	20 mA

## TYPICAL CHARACTERISTICS

Room temperature	0-40°C
Max. Current relay output	6A (resistive load) 1A (inductive load)
4-20mA output	4-20mA (dynamic 0-500Ohm)
pH measure	0-14 (0.01 pH)
ORP (mV) measure	-1000 - +1400 (+/-1mV)



## LEVEL ALARM

Pump stops, LEVEL and ALARM are displayed, and yellow LED is on when the pump detects no product for 5 seconds. A sensor level is required.

## PROGRAMATION

Selection of the parameter to control.

First time pump is on, the parameter is flashing (default parameter is pH).

+/- to change parameter.

Confirm with ENT.

Press ENT, use +/- to select the menu:

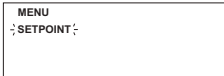

## SETUP



ENT to select

Menu available: BASE(default) / FULL



Press ENT to enter SETUP menu:

+/- to select parameter to control pH, mV  
Confirm with ENT.





Password:

OFF: password disabled

Use +/- to set a password first digit, press ? to go to the next digit.

Confirm with ENT.



Level or flow sensor. +/- to select LEVEL to connect a level sensor, or  for a flow sensor.

Confirm with ENT.

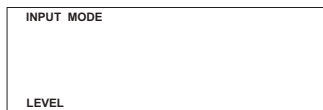

Time to exit the menu after the last button pressed.

+/- to change value.

Confirm with ENT.



Delay time to activate the pump.

+/- to change value.

Confirm with ENT.



To solve problems of inertia of some electrodes, or installations, the delay time switch on of the pump can be set.

## CALIBRATION



press ENT to calibrate

pH calibration:

POINT 1.



Put the sensor in buffer solution pH7.

+/-, to modify value on the display to get 7.00.

Confirm with ENT.

POINT 2

Wash the sensor with water and put it in the second buffer solution (pH 4 or pH9).

+/- to modify value on the display to get the value of the buffer solution.

Confirm with ENT.





ORP (redox) calibration:

POINT 1: Short circuit the BNC connector.

+/- to select 0.

Confirm with ENT.

Point 2: Connect the sensor and put it in the chemical solution (250, 475, 650 mV).

+/- to select the same value of the chemical solution used.

Confirm with ENT

## SET POINT

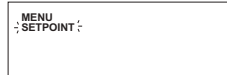

ENT to set the setpoint.

+/- to set the set point value.

Confirm with ENT



Select dosing method. If the pump has to dosify to increase the reading to reach the set point or decrease the reading. To dosify acid, select , to dosify alkaline product .

+/- to select. Confirm with ENT.



HYSTERESIS (only in FULL menu) , is the difference from the set point where the pump starts or stops.

+/- to change value.

Confirm with ENT.



Type of control.

ON-OFF: to get the set point, the pump works at a fixed frequency.

+/- to select. Confirm with ENT.

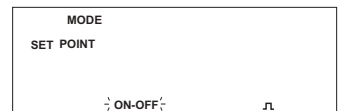

PROP: Frequency of the dosing depends on the reading and the set point distance.

+/- to select. Confirm with ENT.



ON-OFF selected, percentage to dose  
 +/- to change.  
 Confirm with ENT.



ON-OFF selected. SET POINT DELAY. Time allowed to have the reading away of the set point before the pump is activated.  
 +/- to change. Confirm with ENT.



PROP selected. Maximum pH or mV value the pump will work at the maximum frequency.  
 +/- to change. Confirm with ENT.



Maximum frequency to dosify.  
 +/- to change. Confirm with ENT.



Minimum frequency, when set point value is got.  
 +/- to change. Confirm with ENT.



Set up of the 4-20mA signal output. Defines the value of the reading at 4 mA.  
 +/- to change.  
 Confirm with ENT.

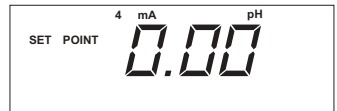

+/- for the value of the reading at 20mA.  
 Confirm with ENT.

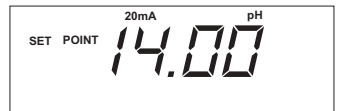

**ALARMS**



ENT to set alarms.

Maximum value where the alarm is on, and stops the dosing. When the reading goes to a correct value the pump is on with the alarm registered on the screen.  
 +/- to change.  
 Confirm with ENT.







Minimum value where the alarm is on, and stops the dosing. When the reading goes to a correct value the pump is on with the alarm registered on the screen.  
+/- to change.  
Confirm with ENT.



OVER DELAY, maximum time to get the set point. If this time is over OVER DELAY alarm is on, and the dosing is stop.  
+/- to change. Confirm with ENT.



**RESET** (partial or total)  
Switch off and on.

Press ENT  press + and - simultaneously



Partial Reset partial gets default settings, but the calibration parameters are not lost.

Press: -, -, ►.



Total reset gets all the default settings..

Press: +, +, ►.



**STAND-BY** pump is stop

Press + and - simultaneously untill

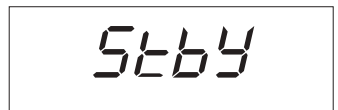

Press + and - to exit.

# DOSITEC MF

## MULTI-FUNCTION DOSING PUMP

Dosing pump allows a manual flow regulation, a proportional dosing referred to a pulse input rate, 4-20mA analogical external signal, or with a timer.

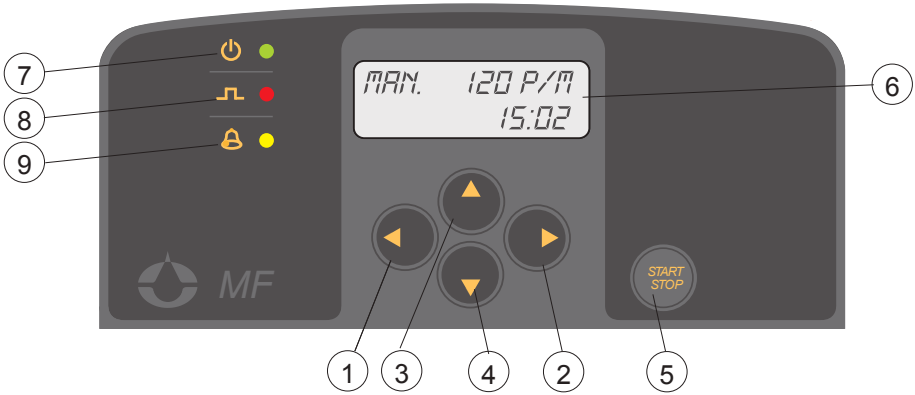

- 1 Decrease
- 2 Increase
- 3 Previous program
- 4 Next program
- 5 START / STOP
- 6 Display
- 7 Power LED
- 8 Injection LED
- 9 Alarm LED

## ACCESORIES

- 1 flexible transparent PVC suction hose of 2m (6.56 feet)
- 1 semi rigid white PE injection hose of 2m (6.56 feet)
- 1 injection valve 3/8"
- 1 filter
- 1 user manual
- 1 flexible transparent PVC priming hose.



## LEVEL ALARM

Pump stops when the pump detects no product for 5 seconds. A sensor level is required.

## PROGRAMMING

First screens

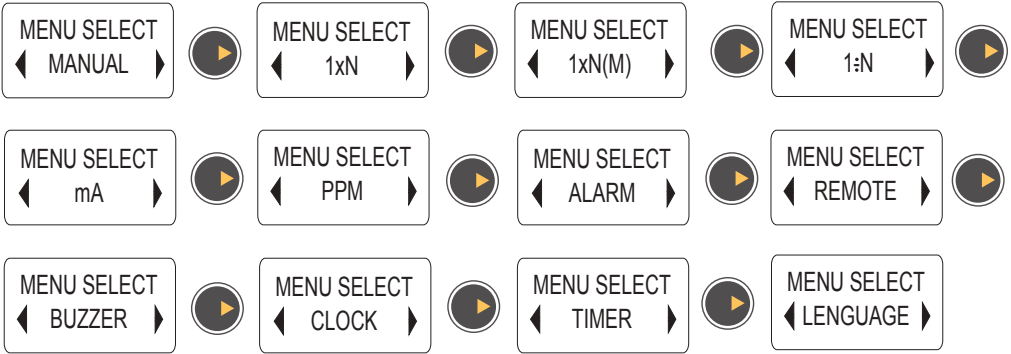

Dosing control modes. MANUAL / 1xN / 1xN(M) / 1:N / mA / PPM:

## MANUAL MODE

Pump runs a constant dosing. Frequency of the injections can be set upon three different scales.

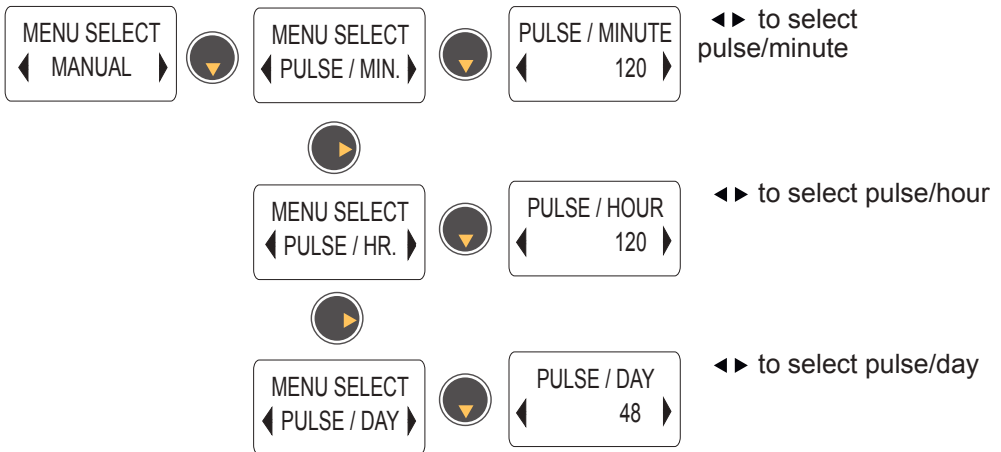

Confirm with START/STOP.  
Pump starts at the selected frequency.

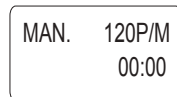



## PROPORTIONAL MODE

Proportional dosing between the pulses of the water counter, and the pump injections.

### 1xN MODE

For each pulse received, the pump injects "N" times. N is set by the user, frequency is set in manual mode.

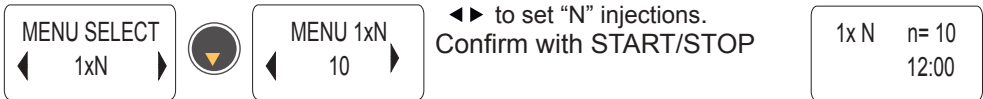

Example:

- Pump set on **1xN** mode.
- N= **20**
- When the pump receives a pulse, it starts dosing 20 injections. If the pump receives another pulse while it is dosing, the pulse is ignored. When the pump finishes the 20 injections, it can accept another pulse.

### 1xN (M) MODE

Works as 1xN mode, but frequency of the pump is adjusted to time between pulses received. If the pump received a pulse while it is dosing, it is memorized and adjusts the frequency again.

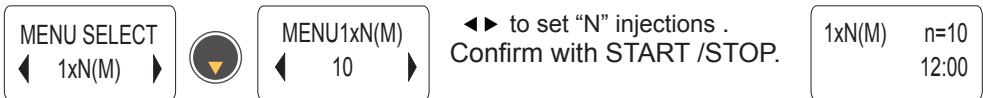

### Overpulse alarm (AL3)

When the number of pulses remaining to inject is higher than 4xN, AL3 is activated. The pump continues working, but the pending injections are not done.

Example:

Pump receives a pulse, dose "N" injections at the maximum frequency (120 injection/minute).

At the second pulse received, the pump adjust the injection frequency to the time between first and second pulse. Maximum limit is maximum frequency.



## 1:N MODE

For each N pulses received the pump injects once. N is set for the user.

MENU SELECT ◀ 1:N ▶		MENU 1:N ◀ 10 ▶	◀▶ to select the number of pulses. Confirm with START /STOP.	1:N    n= 10 12:00
------------------------	--	--------------------	---	-----------------------

Example:

- Pump set on **1:N** mode.
- **N= 20**
- When the pump receives 20 pulses, injects once.

## mA MODE (4-20mA)

Frequency of the injection is adjusted by an external 4-20mA signal. Minimum and maximum injection frequency can be set.

MENU SELECT ◀ mA ▶		SET mA (1) ◀ 4.0 ▶	◀▶ to select minimum mA of the signal. Confirm with .
		SET mA (2) ◀ 20.0 ▶	◀▶ to select maximum mA of the signal. Confirm with .
		PULSE / MIN (1) ◀ 0 ▶	◀▶ to select flow(injections/ minute) of the signal SET mA (1). Confirm with .
		PULSE / MIN (2) ◀ 120 ▶	◀▶ to select flow (injections/ minute) of the signal SET mA(2). Confirm with .
BELOW mA (1) ◀ STOP ▶	BELOW mA (1) ◀ CONTINUE ▶	◀▶ to select STOP or CONTINUE the dosing when signal value is below SET mA (1). Confirm with .	



OVER mA (2)  
◀ STOP ▶

OVER mA (2)  
◀ CONTINUE ▶

◀▶ to select STOP or CONTINUE the dosing when signal value is over SET mA (2).  
Confirm with ▼ .

Pres START/STOP to start running according the configuration set.

mA :00.0  
12:00

### PPM MODE

Doses in Parts Per Million.

MENU SELECT  
◀ PPM ▶



L/P W.METER  
◀ 0.10 ▶

◀▶ to select liters/pulse of the flowmeter.  
Confirm with ▼ .

cc/ INJECTION  
◀ 0,01 ▶

◀▶ to select the injection volume/cycle (ml/cycle) (page 5).  
Confirm with ▼ .

SOLUTION %  
◀ 100 ▶

◀▶ to select the concentration value (%) of the product to inject.  
Confirm with ▼ .

SET PPM  
◀ 1.0 ▶

◀▶ to select the set point in p.p.m (Parts Per Milion), between 0,01-2000 ppm.  
Confirm with ▼ .

START/STOP, to start running according the configuration set.

PPM = 1.0  
12:00

### ALARM

Pump stops, yellow led is on, and the buzzer is activated when the pump detects no injects product programmed (some parameters must be set). A flow sensor is required.

MENU SELECT  
◀ ALARM ▶



REF. PULSES  
◀ 0 ▶

◀▶ number of reference pulses.  
Confirm with ▼ .

MAX DIFF.  
◀ 0 ▶

◀▶ select maximum distance of the ref pulses accepted.  
Confirm with ▼ .



## REMOTE ACTIVATION

The pump can be activated with a contact at a maximum distance of 100 meters. (3-4 Connector C, page 9).

Open contact activation(NORMAL), close contact activation(REVERSED).

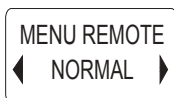
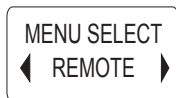

NORMAL

Open contact: pump on

Close contact: pump off

◀▶ to select.

Confirm with ▼ .

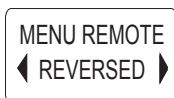

REVERSED

Open contact: pump off

Close contact: pump on

◀▶ to select.

Confirm with ▼ .

## BUZZER

Buzzer shows if the pump alarm is on.

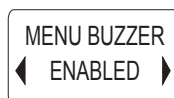

ENABLED

◀▶ to select.

Confirm with ▼ .

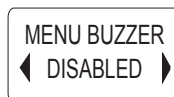

DISABLED

◀▶ to select.

Confirm with ▼ .

## CLOCK

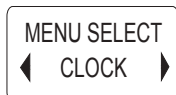

◀▶ select time.

Confirm with ▼ .



◀▶ select day.

Confirm with ▼ .



◀▶ select year

Confirm with ▼ .



CLOCK SET  
◀ 2007 "JAN" 01 ▶

◀▶ select the month.  
Confirm with ▼ .

CLOCK SET  
◀ 2007 JAN "01" ▶

◀▶ select the day.  
Confirm with ▼ .

## TIMER

Timer in a day can activate 8 cycles start-stop of the pump.

MENU SELECT  
◀ TIMER ▶



MENU TIMER  
◀ TIMER OFF ▶

TIMER OFF  
◀▶ select the function.  
Confirm with ▼ .

MENU TIMER  
◀ DAILY SETS ▶

DAILY SETS number of cycles start-stop in a day (max 8).  
◀▶ select function.  
Confirm with ▼ .

SET1  
ON ◀ 1:00 ▶

SET1 ON start time.  
◀▶ select time hour:minute.  
Confirm with ▼ .

SET1  
OFF ◀ 1:20 ▶

SET1 OFF stop time.  
◀▶ select time, hour: minute.  
Confirm with ▼ .

Repeat depending the number of cycles (max. 8) required per day.

MENU TIMER  
◀ WEEK SETS ▶

WEEK SETS maximum of 8 start-stop cycles in a week.  
◀▶ select function.  
Confirm with ▼ .

SUNDAY SET1  
ON ◀ 1:00 ▶

SUNDAY SET 1 ON .  
◀▶ select time.  
Confirm with ▼ .





SUNDAY SET1  
OFF ◀ 1:20 ▶

SUNDAY SET 1 OFF Sunday stop time.  
◀▶ to select time.  
Confirm with ▼ .

Repeat for cycles number of each day of the week.  
Maximum 8 for each day.

## LANGUAGE

Select language.

MENU SELECT  
◀ LANGUAGE ▶



SET LANGUAGE  
◀ ENGLISH ▶

English.  
◀▶ select language.  
Confirm with ▼ .

MENU LINGUA  
◀ ITALIANO ▶

Italian.  
◀▶ select language.  
Confirm with ▼ .



## 7.- MAINTENANCE



*Before any maintenance operation check:*

*The pump is stopped and disconnected from the electric supply.*

*There is no pressure neither inside the head nor in the impulsion pipe. It is advisable to empty the head before opening it.*

*The staff in charge of the maintenance will use the adequate protection means in order to manipulate the dosed liquid.*



Periodically check the chemical tank level to avoid the pump operates without liquid. This would not damage the pump, but may damage the process plant due to lack of chemical. DOSITEC series dosing pumps are all supplied with level control setting. The level switch is not included therefore to be ordered separately.

Level control stops pump operation once the level into the chemical is lower then the level switch,activating a L.E.D. on the pump .



Check the pump operating condition at least every 6 months, pump head position,screws, bolts and seals; check more frequently when aggressive chemicals are used.



Is recomended to clean periodically the hydraulic part(valves and filter). Cleaning frecuency will depend on the aplication.



## TROUBLE SHOOTING

### MECHANICAL FAULTS

As the system is quite robust there are no apparent mechanical problems.

Occasionally there might be a loss of liquid from the nipple because the tube nut has loosened, or more simply the discharge tubing has broken.

Very rarely there may be losses caused by the breakage of the membrane, or by the membrane seals in which case they have to be replaced by disassembling the four screws of the pump head, when re-mounting the pump head ensure that the screws are replaced properly, along with "O" ring.

After repair, the metering pump will need to be cleaned of additive residues which can damage the pump case.

PROBLEM	CAUSE	SOLUCIÓN
The pump gives pulses but doesn't inject	Valves not clean	Remove the suction and injection valves, clean them, and assemble them in the same position.
	Damaged valves	When the parts are swollen, check valve material against a chemical compatibility chart and fit the correct material.
	Filter not clean	Clean the filter
The pump doesn't give any pulse and LED are off	Power supply failure	Check the power supply. If it still doesn't work contact with the Technical Service
The pump doesn't give any pulse and green LED is on and red LED is off	START failure	Press START/STOP. If it still doesn't work contact with the Technical Service.
Pump pulses are not constant	Power supply failure	Check the input voltage is within +/- 10% rated voltage
The pump gives only one pulse		Disconnect the pump and contact immediately to the Technical Service

# DOSITEC PARTS

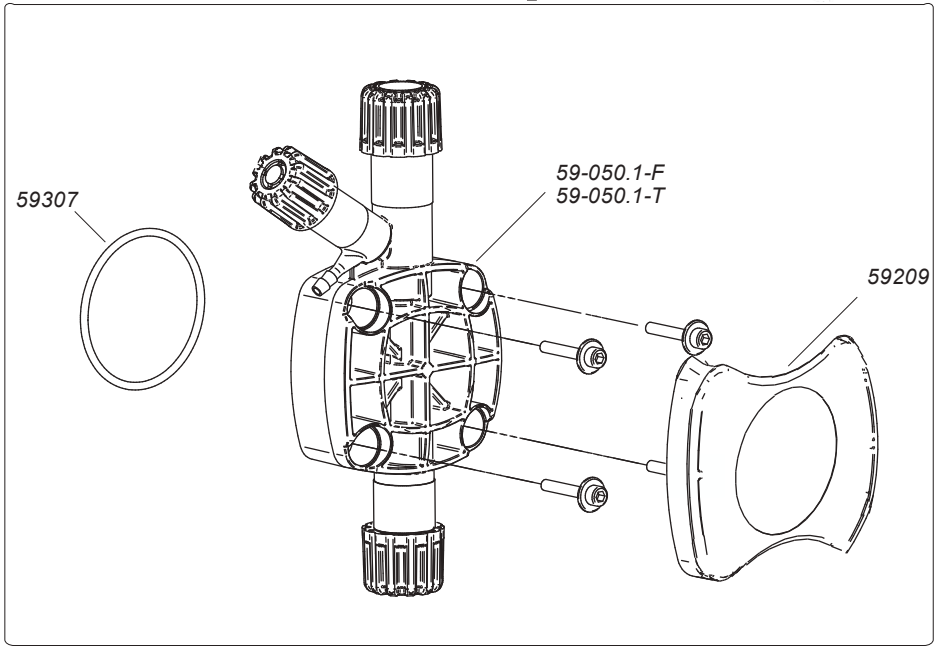
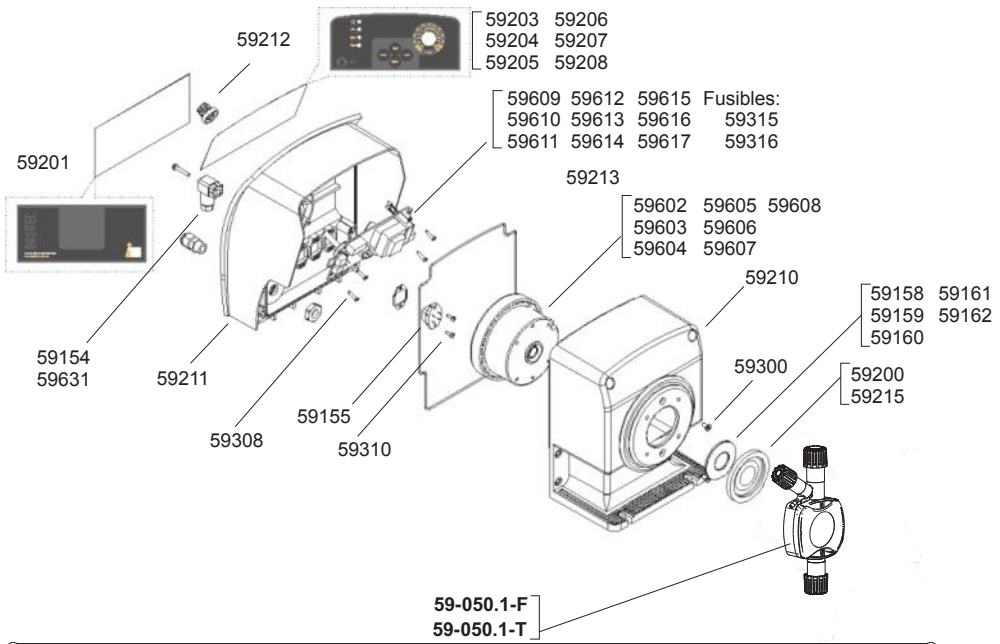



## KIT ACCESORIOS DOSITEC PP 59-049-P

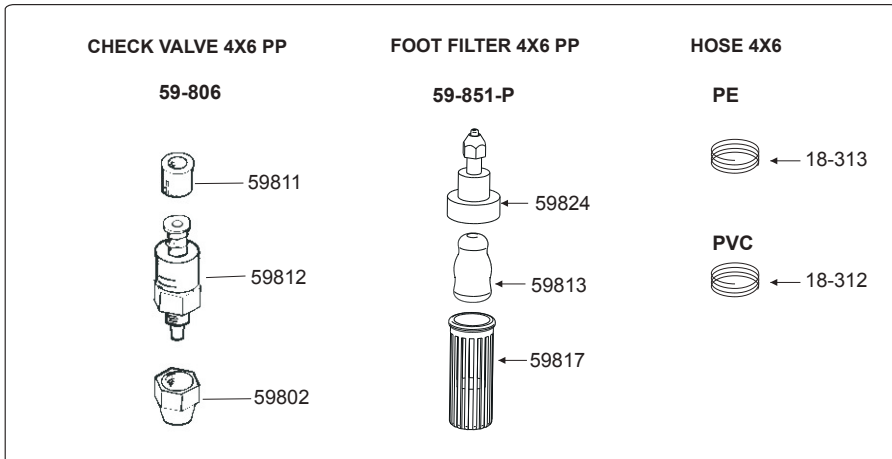

## KIT ACCESORIOS PVDF 59-049-F

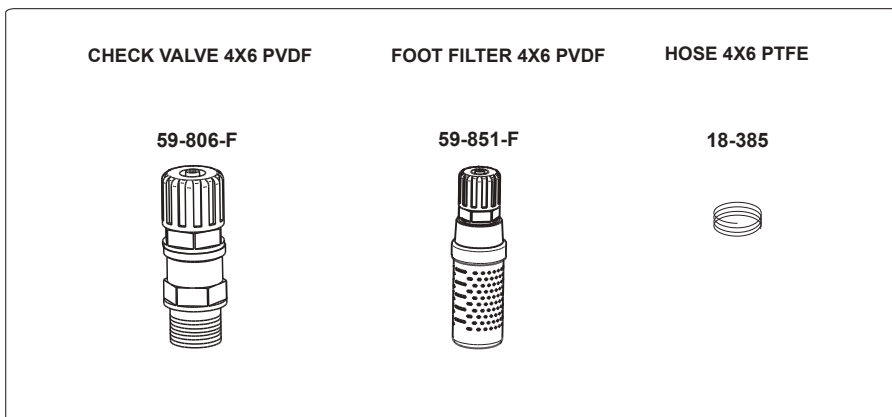



# LIST OF PARTS

CODE	DESCRIPTION	UNITS	CODE	DESCRIPTION	UNITS
59154	Connector female 4 pins Dositec	2	59807-F	Drain knob PVDF	1
59155	Conector g4a5m Dositec	2	59809-F	Screw for priming Dositec PVDF	1
59157	Cylinder cap	4	59810-F	Drain rod Dositec PVDF	1
59158	Diaphragm backseat Dositec 2.5	1	59811	Cylinder for injections valve	1
59159	Diaphragm backseat Dositec 6	1	59812	Body of injections valve	1
59160	Diaphragm backseat Dositec 9	1	59813	PP fiber foot filter 4x6-3/8	1
59161	Diaphragm backseat Dositec 2-20	1	59814	Lip valve for foot filter	1
59162	Diaphragm backseat support Dositec 2-20	1	59817	Foot filter body	1
59200	Diaphragm PTFE Dositec	1	59824	Connector for foot valve 4x6 with filter	1
59201	Lower lexan Dositec	1	59829	Nut for 3/8" valve connector PVDF	1
59203	Lexan MP	1	59830	Valve flange pipe 4x6 PVDF	1
59204	Lexan MD	1	59831	Valve connector pipe 4x6 PVDF	1
59205	Lexan Q	1			
59206	Lexan mA	1			
59207	Lexan MF	1			
59208	Lexan PRC	1			
59209	Cylinder cover	1	<b>ASSEMBLIES</b>		
59210	Hydraulic case	1	59-050.1-F	Cylinder Dositec assembly PVDF FKM	1
59211	Electronic case Dositec	1	59-806	Injection check valve 4x6 3/8	1
59212	Flow adjustment knob	1	59-851-P	Foot check valve 4x6 with PP fiber filter	1
59213	O-ring case	1			
59215	Diaphragm PTFE Dositec 2-20	1	<b>OPTIONS &amp; ACCESORIES</b>		
59300	Screw M4x8 A2	4	18311	Floating level switch	1
59303	O-ring 4,76 x 1,78 FPM priming valve	2	18385	Hose 4x6 PTFE Dositec	1
59307	O-ring 48.89x2.62 FPM	1	59-049-F	Kit accessories Dositec PVDF	1
59308	Screw 2,9x9,5	4	59-050.1-T	Cylinder Dositec assembly PVDF EPDM	1
59309	Screw 4x16	6	59-080-F	Cylinder with automatic degassing valve assembly PVDF	1
59310	Screw 2,9x13	2	59101	Plate for level sensor stand	1
59315	Fuse 1A Dositec Q/PRC	1	59-806-E	Injection check valve 4x6 3/8 EPDM	1
59316	Fuse 1A 20x5 Dositec MP/MD/MA/MF	1	59-806-F	Injection check valve ball 4x6 1/2 PVDF	1
59602	Electromagnet D80 2/12V	1	59-851-F	Foot check valve 4x6 with PVDF filter	1
59603	Electromagnet D80 6-7 12V	1			
59604	Electromagnet D90 9-5 12V	1			
59605	Electromagnet D80 2-10	1			
59606	Electromagnet D80 6-7	1			
59607	Electromagnet D90 9-10	1			
59608	Electromagnet 2-20	1			
59609	Electronic card Dositec MP 12Vdc	1			
59610	Electronic card Dositec MP	1			
59611	Electronic card Dositec MD	1			
59612	Electronic card Dositec Q	1			
59613	Electronic card Dositec mA	1			
59614	Electronic card Dositec MF	1			
59615	Electronic card Dositec PRC	1			
59616	Electronic card (power)12Vdc Dositec MF	1			
59617	Electronic card (power) 230Vac Dositec MF	1			
59631	Connector female 4 pins Dositec ALM	1			
59800-F	Drain connector Dositec PVDF	1			
59801-F	Spacer of injection valve PVDF	1			
59802	Nut for 3/8" lip valve connector	1			

## EC CONFORMITY DECLARATION



I.T.C S.L..  
Vallès, 26  
Polígono Industrial Can Bernades-Subirà  
08130 Santa Perpètua de Mogoda

*Declares that all models DOSITEC products, identified by a serial number and year of manufacture, strictly fulfill low voltages directives D2014/35/UE and electromagnetic compatibility directives D2014/30/UE as long as installation, use and maintenance are carried out following the prevailing regulation and following the instructions contained in the handbook.*

Antón Planas  
Manager

## WARRANTY



*I.T.C. S.L. warrants the product specified in this document for a period of 2 years from the purchase date except for the wearing parts such as valves, seals, nipples, hoses and filter. This warranty obligation is limited to the free replacement of the damaged parts due to any material or manufacture defect. This warranty does not include periodic maintenance and damage resulting from misuse.*

*The equipment must be sent to I.T.C. S.L. Service Center with prepaid transport charges, and will be sent back with transport charges for customer's account.*

*The warranty document with sales date and shop stamp or an invoice copy must be sent with the equipment.*

MODEL

\_\_\_\_\_

SERIAL #

\_\_\_\_\_

Date of sale and shop stamp

DATE:

\_\_\_\_\_

Original manual

Ed:07/02/19 -EN

---



C/ Vallès, 26 Pol. Ind. Can Bernades - Subirà  
P.O. Box 60  
08130 Santa Perpètua de Mogoda  
BARCELONA

*Tel. 93 544 30 40 Fax 93 544 31 61*  
*e-mail: [itc@itc.es](mailto:itc@itc.es) [www.itc-dosing-pumps.com](http://www.itc-dosing-pumps.com)*